



EST3X Life Safety Control System



FDNY
COA 6087



7165-1657:
0186/0306



Description

EST3X represents the latest generation of life safety control panels for mid to large sized applications. With large multi-message displays and innovative controls, intuitive interfaces, and bold colored cabinets — these systems capture the imagination, and catch the eye. But behind the LCD display is where they really shine.

New microprocessors and chipsets take full advantage of the latest advances in computing technology, leading to smarter, faster, higher-capacity processing and more efficient designs. EST3X's patented Voltage Boost™ technology, for example, delivers consistent voltage — even at low battery power — resulting in lighter cable requirements and/or longer runs. That saves time and money.

High performance processing also leads to powerful networking features and versatile digital audio functionality. The wide range of EST3X configurations include standalone operation, networking with up to 64 nodes, or integration with an EST3 network comprising as many as 64 nodes — complete with mass notification capabilities and display of security events.

EST3X sets a new standard in front-panel life safety control interfaces. Its exclusive SpeedTouch™ rotary control offers nimble forward and back scrolling through events and options, while a mere tap of the control selects items with an unprecedented fluidity of motion. Its extra-large backlit display reveals up to eight concurrent messages, and switch/LED strips provide ample space for meaningful custom labels. And for end users, large tactile control buttons instill confidence and promote quick response when time is of the essence.

Standard Features

- Up to six intelligent analog loops hosting as many as 1,500 Signature Series devices per panel
- Optional integrated eight-channel digital audio
- 10 amp power supply with universal 94 to 264 Vac input voltage
- Patented Voltage Boost™ technology delivers consistent voltage — even at low battery power
- Four built-in 3-amp notification/auxiliary circuits
- Large 24-line by 40-character backlit LCD
- Simplified operation with the SpeedTouch™ rotary control
- 65 amp hour battery charger
- 64-node network nodes using copper and/or fiber
- Supports up to 30 R-Series remote annunciators
- Removable terminals on all low voltage wiring
- Space for up to three additional option cards such as extra SLC loops, amplifiers, or dialer/modem
- Optional Ethernet interface
- 1,100 event history log
- Optional earthquake hardening: OSHPD seismic pre-approval for component Importance Factor 1.5
- UL2572 Listed for Mass Notification
- UL864 UUKL Listed for Smoke Control
- UL864 Listed for releasing applications using SIGA-REL

Application

Application flexibility is where EST3X's leading edge computing power is put to best use. This generation of control panels is equally at home as the center of a simple single-building standalone system as it is when part of a sophisticated life safety network serving thousands of points across multiple buildings. Optional voice evacuation bridges the gap left by other mid-range systems, and makes these panels a cost-effective solution for most applications.

Strong Networking

Networking is among EST3X's strong suits. Highly efficient RS485 connectivity, plus fiber-optic communications deliver faster response times and more sophisticated diagnostic capabilities, while cost-effective remote annunciation solutions keep basic monitoring and control always within reach.

A simple EST3X network can comprise up to 64 nodes – enough to serve the needs of most campuses and larger buildings. Its ability to join an EST3 network with as many as 64 nodes extends EST3X's reach into mass notification applications, security reporting, as well as making it an ideal candidate for retrofits.

High Capacity Audio

EST3X features a full eight channels of integrated digital audio with up to two minutes of on-board programmable message storage. An optional high quality paging microphone gives live access to local, as well as remote, audio functions. Auxiliary inputs are available for mass notification operations, and ZA Series amplifiers may be mounted directly on the EST3X rail assembly.



An optional paging microphone provides local, as well as remote, audio functions.

Seamless System Integration

EST3X borrows much from its larger sibling, the venerable EST3 Life Safety Platform. And for good reason: by integrating with the EST3 networking and computing environment, an EST3X control panel can serve as a cost-effective remote node for extinguishing, smoke control, or even mass notification functions – all within the same compliance framework.

Retrofits and expansions benefit enormously from this arrangement, but programming and equipment management for new installations is equally efficient as a result of these shared resources. EST3X will accommodate up to three EST3 modules on its own rail assembly, giving it access to such proven EST3 successes as zoned amplifiers, conventional device circuits, modem communicators, and RS-485 functions. Meanwhile, installers familiar with EST3 configuration will find that the two systems share many of the same programming and diagnostic conventions.

Local and Remote Annunciation

Up to 30 R-Series LCD, LED annunciators and driver interface cards may be configured for each node on the EST3X network. No additional nodes are required for annunciation purposes. In addition, EST3X supports EST3 network annunciators, while GCI and GCIX driver interface cards provide cost-effective graphic annunciation solutions. And all annunciator inputs and outputs are easily programmable through the rules and labels function of EST3X's Software Definition Utility.



Up to 30 R-Series annunciators may be configured for each node on the EST3X network.

Power to Count On

Edwards' patented Voltage Boost™ technology delivers a consistent 22.5 Vdc – even at low battery power. This means lighter gauge cable can be used for equivalent distances compared with conventional power supplies, or longer wire runs on the same gauge cable. Either way, this breakthrough technology saves time and equipment costs, making EST3X not only a high-performance solution – but a cost-effective one as well.

EST3X's four on-board Notification Appliance Circuits are fully synchronized to UL 1971 standards – without the need for external modules or other electronics. Its ample 10-amp power supply is finely tuned to get the most out of Edwards' widely-acclaimed low profile Genesis notification appliances.

Dimensions

The backbox is designed for semiflush or surface mounting. Conduit and nail knockouts, keyhole style mounting holes, and wide wiring troughs facilitate efficiency during installation.

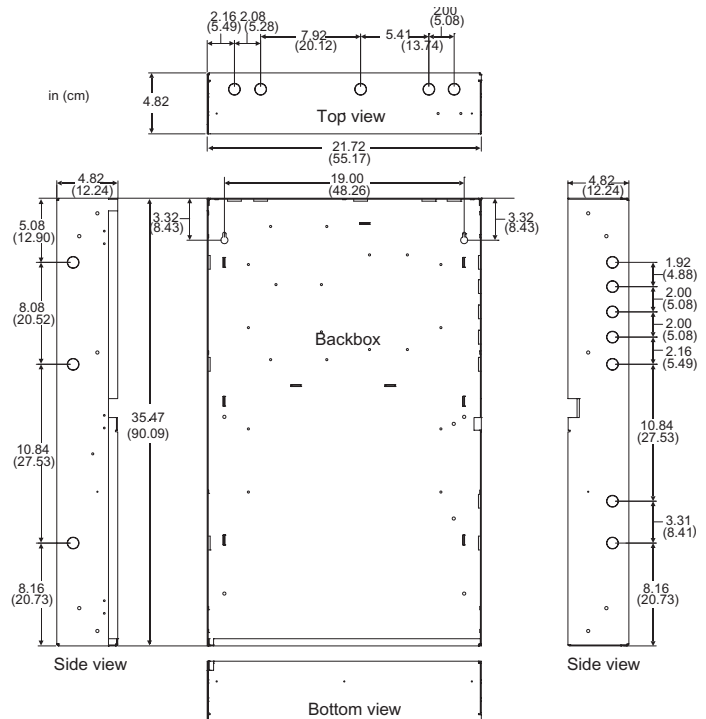

Note: Add 0.25 in (0.64 cm) to height and width dimensions to allow for knockouts when framing in the backbox for semiflush mounting.

System Layout

Up to six intelligent analog loops hosting as many as 250 devices each.

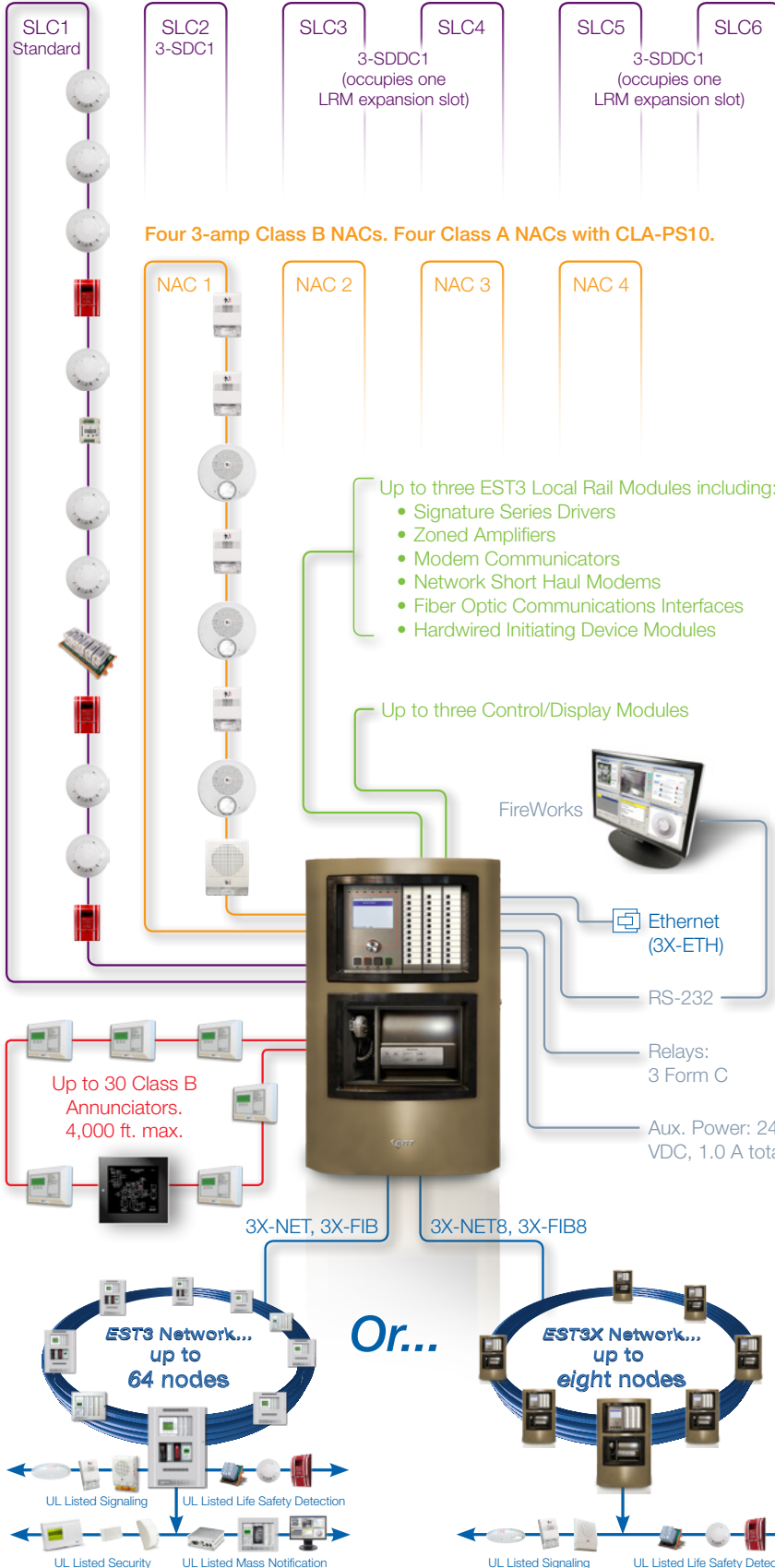

Wiring

Signature (initiating) Data Circuit

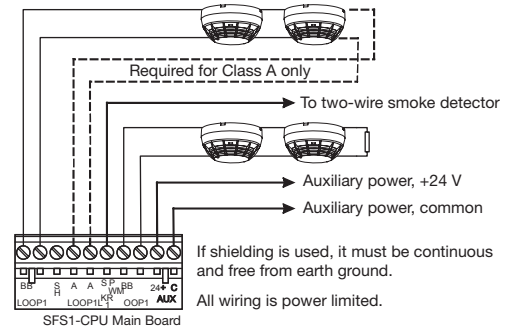

Notification Appliance Circuits

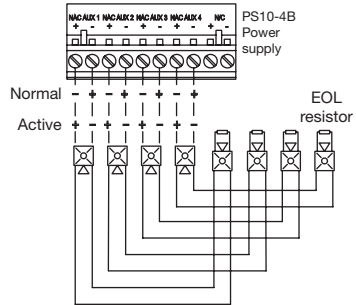

Wiring is supervised and power limited.

TB2 terminal marking indicates signal polarity when the circuit is active. Polarity reverses when the circuit is active.

For proper circuit supervision, break the wire run at each notification appliance and install the EOL resistor at the end of the circuit.

Do not loop wires around notification appliance terminals.

Network data circuit

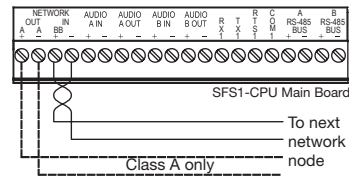

Network data circuit, Class B audio

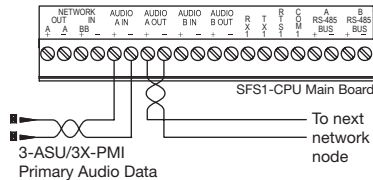

Network data circuit, Class A audio

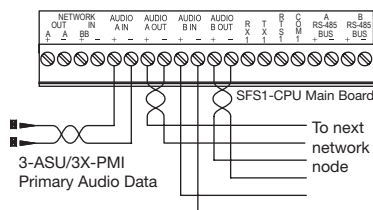

Main Component Assembly

EST3X systems are designed for quick assembly and easy access in the field. Components are modular and require no special tools to service or replace.

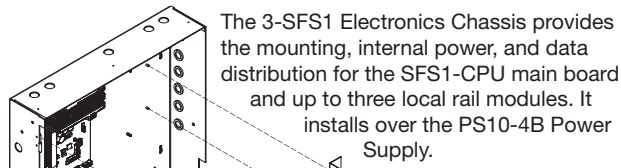

The SFS1-CPU main board mounts to the Electronics Chassis.

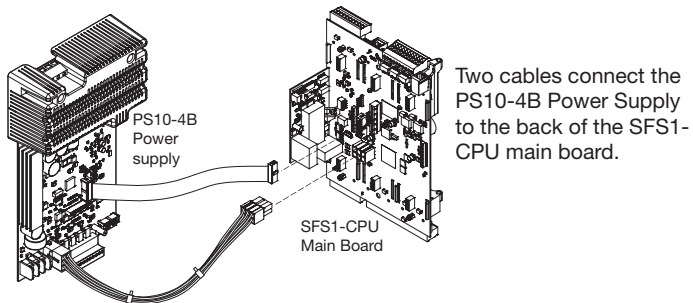
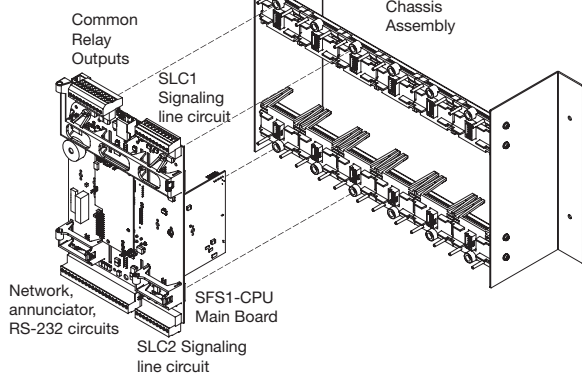

The 4X-LCD assembly mounts to hinge pins on the CPU and connects with a single ribbon cable.

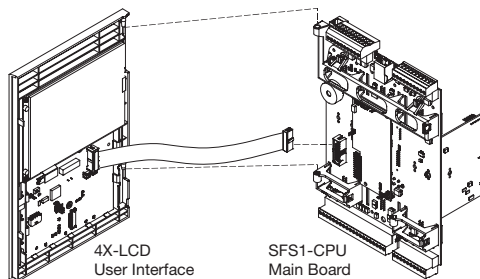

SFS1-CPU Main Board

The SFS1-CPU main board processes all information from modules installed within the cabinet as well as data received from other panels over the network data riser. When a network card is installed, the CPU employs a command set to determine its type.

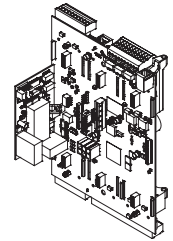

SFS1-CPU Specifications

Voltage	24 VDC
Current	Standby 115 mA at 24 VDC Alarm 115 mA at 24 VDC
Relay outputs	Quantity 3 (alarm, supervisory, and trouble) UL type Common Contact arrangement Form C Rating 30 VDC at 1 A resistive
AUX power outputs	Quantity 2 Voltage 24 VDC, resettable or continuous Current 1.0 A each circuit, 1.0 A total
Data network (RS-485)	Nodes 2 to 64 (requires optional network card) Performance class Class A or Class B Wire type Twisted pair, 6 twists per foot, min. Circuit length 5,000 ft. (1,524 m) between any three panels Circuit resistance 90 Ω , max. Circuit capacitance 0.3 μ F, max.
Serial Port (RS-232)	<i>The on-board serial port supports communication to the FireWorks graphical users interface or the FSB-PC series of protocols converters for ancillary communications to BMS systems.</i> Circuit length 20 ft. (6 m) max. Circuit resistance 13 Ω , max. Circuit capacitance 0.7 μ F, max.
Annunciator port (RS-485)	Performance class Class B and Redundant Class B Baud rate 9600 and 38400 Wire type Twisted pair, 6 twists per foot, min. Circuit length 4,000 ft. (1,219 m) Circuit resistance 90 Ω , max. Circuit capacitance 0.3 μ F, max.
Signaling line circuit	Quantity 2 (second SLC requires optional 3-SDC1 card) Performance class Class A or Class B Circuit capacity 125 detectors, 125 single address modules Circuit resistance 100 Ω , max. Circuit capacitance 0.5 μ F, max.
Wire size	18 to 12 AWG (0.75 mm ² to 2.50 mm ²)
Ground fault impedance	10 k Ω
Operating environment	Temperature 32 to 120°F (0 to 49°C) Relative humidity 0 to 93% noncondensing

Notes

- For battery calculations, standby and alarm currents include all listed primary power supplies.
- The common trouble relay operation does not include AC trouble delay functionality and cannot be used for reporting troubles off premises per UL 864 9th edition.

PS10-4B Power Supply Card

The PS10-4B Power Supply Card provides the required power and related supervision functions for the control panel, as well as filtered, regulated power to the rail chassis modules. It also provides 24 VDC for operating ancillary equipment.

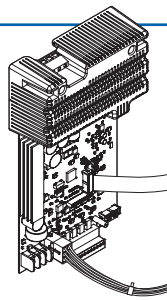

PS10-4B Specifications

Mains voltage	94 to 264 VAC, 50/60 Hz
AC Input Current	
Standby	1.5 amps
Alarm	3.0 amps
Brownout level	93 VRMS
Battery charging capacity	65 Ah max.
Total Power	Voltage 24vdc
Standby Current	88mA
Alarm Current	169mA
Supply Ratings	Current 10 amps (UL), 9.0amps (ULC)
Notification appliance/Auxiliary power circuits	
UL rating	
Quantity	4
Circuit configuration	Class B ¹
Output voltage	Special: 24 Vdc Regulated: 24 Vdc
Output current	Special: 3 amps Regulated: 1.5 amps
EOLR	15 k Ω (UL P/N EOL-15, ULC P/N EOL-P1)
Wiring	
Mains input ²	Supervised, non power-limited
Battery input	Supervised, non power-limited
NAC outputs	Supervised, power-limited
Wire size	18 to 12 AWG (0.75 mm ² to 2.50 mm ²)
Ground fault impedance	10 k Ω
Operating environment	
Temperature	32 to 120 °F (0 to 49 °C)
Relative humidity	0 to 93% noncondensing

¹Class A when a CLA-PS10 Class A adapter card is installed.

²Connect the mains supply using a dedicated branch.

3-SDC1 Signature Data Circuit Card

Each 3-SDC1 Signature Data Circuit Card provides one Class A or Class B signaling line circuit (SLC1) that supports up to 125 Signature Series detectors and 125 Signature Series module addresses. These modules also provide connection for powering conventional two-wire smoke detector circuits on Signature Series modules.

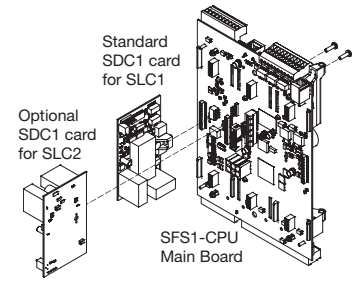

EST3X comes standard with one 3-SDC1 card installed as SLC1. An optional second 3-SDC1 card may be installed to provide SLC2, thus doubling system signaling line capacity.

3-SDC1 Specifications

Voltage	24 VDC
Operating current with fully loaded loop	
Standby	3-SSDC1 144 mA; 3-SDDC1 264 mA
Alarm	3-SSDC1 204 mA; 3-SDDC1 336 mA
Smoke power	19.95 VDC max. ¹
Circuit	
Configuration	Class B, Style 4, DCLB; Class A, Style 6, DCLA
Capacity	125 Signature Series detectors and 125 Signature Series modules per SLC
Resistance	100 Ω with 250 devices
Capacitance	0.5 μ F max.
Wire size	12 AWG (1.5 mm ²) max.
Termination	Removable plug-in terminal strips on the SFS1-CPU main board and Signature module
Operating environment	
Temperature	32 to 120 °F (0 to 49 °C)
Relative humidity	0 to 93% noncondensing

¹For special applications, refer to EST3 ULI/ULC Compatibility Lists (P/N 3100427)

4X-LCD User Interface

Included in the EST3X basic package, the 4X-LCD provides the user interface for the EST3X system. It connects to the SFS1-CPU main board with a ribbon cable, and attaches to the CPU via hinges. Only one display module is required to provide a point of control for the entire network. Additional displays can be added to any EST3X panel in the network to provide additional points of control.

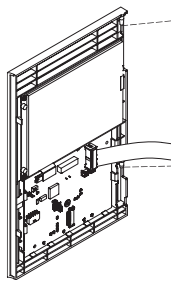

4X-LCD Specifications

Operating current	
Standby	55mA
Alarm	66mA
LCD display	Backlit liquid crystal display 240 x 320 pixels 24 lines of 40 characters
Operating environment	
Temperature	32 to 120 °F (0 to 49 °C)
Relative humidity	0 to 93% noncondensing

SFS1 LED Control/Display Module

The SFS1 LED Control/Display Module provides additional operator interface capability for the SFS1 system. It can be mounted on any of the three right-most local rail modules on the 3-SFS1 electronics chassis. Inserts are provided for labeling switches and LEDs.

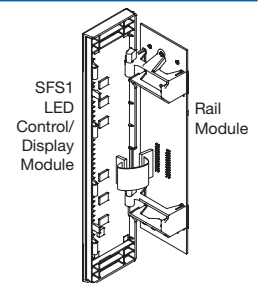

SFS1 Specifications

Voltage	24 VDC
Operating current	
Standby	2.0 mA plus 1.5 mA for each active LED
Alarm	2.0 mA plus 1.5 mA for each active LED
Operating environment	
Temperature	32 to 120 °F (0 to 49 °C)
Relative humidity	0 to 93% noncondensing

3X-FIB fiber optic network module

The 3X-FIB fiber optic network module gives an EST3X panel the ability to network 64 EST3X panels, or interface with an EST3 network. Both Class A and Class B connections are supported. The module consists of the adapter card and electronics card.

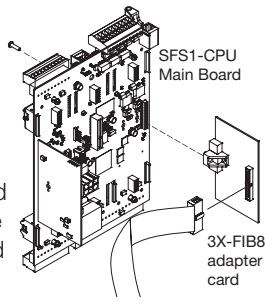

The 3X-FIB supports the following fiber optic transceivers:

Model	Description
SMXLO2	Standard output single mode fiber optic transceiver
SMXHI2	High output single mode fiber optic transceiver
MMXVR	Standard output multimode fiber optic transceiver

The 3X-FIB provides terminals for connecting a 24 VDC backup power source to maintain data transmissions in the event the panel is powered down.

Note: All networked panels must have the 3X-FIB network card installed.

3X-FIB Specifications

Voltage	19.2 to 27.6 VDC (24 VDC nominal)	
Fiber optics network and audio		
Budget		
	SMXLO2	15 dBm between two interfaces
	SMXHI2	25 dBm max. and 8 dBm min. 10 dBm between two interfaces
	MMXVR	50/125, 62.5/125, or 100/140 for MMXVR
Cable type		
Connectors	50/125, 62.5/125, or 100/140 for	
	SMXLO2, SMXHI2	Type Duplex SC
	MMXVR	Type ST
Network data circuit		
Circuit configuration	Class B (style 4) or Class A (style 7)	
Data rate	19.2 K, 38.4 kbps	
Isolation	Isolated from previous panel CPU when using copper. Total isolation when using fiber optics.	
Digitized audio data circuit		
Circuit configuration	Class B (style 4) or Class A (style 7)	
Data rate	327 kbps	
Isolation	Isolated from previous panel CPU when using copper. Total isolation when using fiber optics.	
Copper wired network data circuit segment		
Circuit		
	Length	5,000 ft. (1,524 m) max. between any three panels
	Resistance	90 Ω max.
	Capacitance	0.3 μ F max. ¹
	Wire type	Twisted Pair, 18 AWG (0.75 mm ²) min.
Operating environment		
	Temperature	32 to 120 °F (0 to 49 °C)
	Relative humidity	0 to 93% noncondensing

¹Include shield capacitance, if shielding is used.

3X-FIB8 fiber optic network module

The 3X-FIB8 fiber optic network module gives an EST3X panel the ability to network up to eight EST3X nodes. Both Class A and Class B connections are supported. The module consists of the adapter card and electronics card.

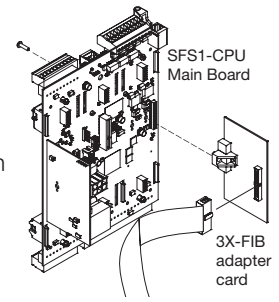

The 3X-FIB8 supports the following fiber optic transceivers:

Model	Description
SMXLO2	Standard output single mode fiber optic transceiver
SMXHI2	High output single mode fiber optic transceiver
MMXVR	Standard output multimode fiber optic transceiver

The 3X-FIB8 provides terminals for connecting a 24 VDC backup power source to maintain data transmissions in the event the panel is powered down.

Note: All networked panels must have the 3X-FIB8 network card installed.

3X-FIB8 Specifications

Voltage	19.2 to 27.6 VDC (24 VDC nominal)	
Fiber optics network and audio		
Budget		
	SMXLO2	15 dBm between two interfaces
	SMXHI2	25 dBm max. and 8 dBm min. 10 dBm between two interfaces
	MMXVR	50/125, 62.5/125, or 100/140 for MMXVR
Cable type		
Connectors	50/125, 62.5/125, or 100/140 for	
	SMXLO2, SMXHI2	Type Duplex SC
	MMXVR	Type ST
Network data circuit		
Circuit configuration	Class B (style 4) or Class A (style 7)	
Data rate	19.2 K, 38.4 kbps	
Isolation	Isolated from previous panel CPU when using copper. Total isolation when using fiber optics.	
Digitized audio data circuit		
Circuit configuration	Class B (style 4) or Class A (style 7)	
Data rate	327 kbps	
Isolation	Isolated from previous panel CPU when using copper. Total isolation when using fiber optics.	
Copper wired network data circuit segment		
Circuit		
	Length	5,000 ft. (1,524 m) max. between any three panels
	Resistance	90 Ω max.
	Capacitance	0.3 μ F max. ¹
	Wire type	Twisted Pair, 18 AWG (0.75 mm ²) min.
Copper wired audio data circuit		
Circuit		
	Length	5,000 ft. (1,524 m) max. between any three panels
	Resistance	90 Ω max.
	Capacitance	0.09 μ F, max ¹
	Wire type	Twisted pair, 18 AWG (0.75 mm ²) min.
Operating environment		
	Temperature	32 to 120 °F (0 to 49 °C)
	Relative humidity	0 to 93% noncondensing

¹Include shield capacitance, if shielding is used.

3X-NET Network Adapter Card

The 3X-NET network adapter card gives an SFS1-CPU main board the ability to network up to 64 nodes on an EST3 network. The card supports Class B and Class A wiring.

The 3X-NET adapter card provides two independent RS 485 circuits: one for network data communications and one for digital audio communications.

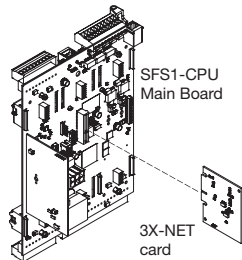

3X-NET Specifications

Voltage	24 VDC
Operating Current	
Standby	98 mA at 24 VDC
Alarm	98 mA at 24 VDC
Circuit configuration	
Network data	Class A, Style 6 & Class B, Style 4
Network audio	Class A, Style 6 & Class B, Style 4
Isolation	
Network data	Network A port not isolated; Network B port isolated
Network audio	Audio A IN and Audio B IN isolated Audio A OUT and Audio B OUT not isolated
Wire size	Twisted pair ¹ 18 AWG (0.75 mm) min.
Circuit length	5,000 ft. (1,524 m) between any three panels
Circuit resistance	90 Ω max.
Circuit capacitance	Data: 0.3 μF max.; Audio 0.09 μF max.
Operating environment	
Temperature	32 to 120 °F (0 to 49 °C)
Relative humidity	0 to 93% noncondensing

¹Six twists per foot minimum

3X-ETH1 Ethernet Adapter Card

The 3X-ETH1 adapter card provides a standard 10/100 Base-T Ethernet network connection for panel programming, diagnostics, and status monitoring. Four LEDs on the adapter card indicate card and network status.

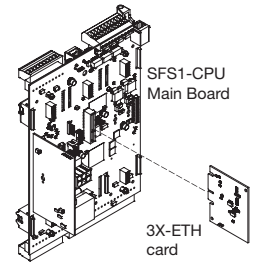

3X-ETH1 Specifications

Ethernet	10/100 Base-T
Voltage	24 VDC
Operating current	
Standby	42 mA at 24 VDC
Active	54 mA at 24 VDC
Connection mode	Auto negotiation
Wire runs	
Distance	200 ft. (60 m) max. ¹
Type	Cat 5
Connector	RJ-45
Operating environment	
Temperature	32 to 120 °F (0 to 49 °C)
Relative humidity	0 to 93% noncondensing

¹Panel to communication equipment

3X-NET8 network card

The 3X-NET8 RS-485 network card gives an SFS1-CPU main board the ability to network through dedicated copper wire up to eight EST3X control panels. The card supports Class B and Class A wiring.

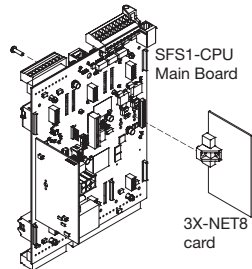

Note: All networked panels must have a 3X-NET8 network card installed.

3X-NET8 Specifications

Voltage	24 VDC
Operating Current	
Standby	98 mA at 24 VDC
Alarm	98 mA at 24 VDC
Circuit configuration	
Network data	Class A, Style 6 & Class B, Style 4
Isolation	
Network data	Network A port not isolated, Network B port isolated
Wire size	Twisted pair ¹ 18 AWG (0.75 mm) min.
Circuit length	5,000 ft. (1,524 m) between any three panels
Circuit resistance	90 Ω max.
Circuit capacitance	0.3 μF max.
Operating environment	
Temperature	32 to 120 °F (0 to 49 °C)
Relative humidity	0 to 93% noncondensing

¹Six twists per foot min.

3X-PMI Paging Microphone Interface

The 3X-PMI Paging Microphone Interface provides controls for emergency voice/alarm communications. It consists of an audio mounting bracket, EAEC Emergency Audio Evacuation Controller card, audio enclosure, and paging microphone.

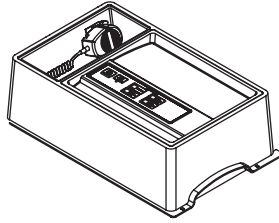

3X-PMI Paging Microphone Interface Specifications

Voltage	24 VDC	
Current	Standby	23mA
	Alarm	29mA
Ground fault impedance	10 kΩ	
Wire size	18 to 12 AWG (0.75 to 2.50 mm ²)	
Audio channels	8 simultaneous	
Audio inputs	Local microphone	Isolated and supervised
	Remote microphone	Isolated and supervised
	Remote audio	Isolated and supervised
EAEC communication	See the EAEC Emergency Audio Evacuation Control Installation Sheet (P/N 3101789)	
Messages	Storage	2 min. total
	Length	39 sec. max.
Controls and indicators	Common	
	Paging Volume	Indicates relative signal strength during active page
	Ready To Page	Flashes during preannouncement tone, steady when ready to page
	Paging Microphone	All Call Activates/deactivates page to all areas
	All Call Minus	Activates/deactivates page to areas not receiving EVAC or Alert message
	Page To Evac	Activates/deactivates page to areas currently receiving the EVAC message
	Page To Alert	Activates/deactivates page to areas currently receiving the Alert message
Operating environment	Temperature	32 to 120°F (0 to 49°C)
	Relative humidity	0 to 93% noncondensing

SFS1-CPU

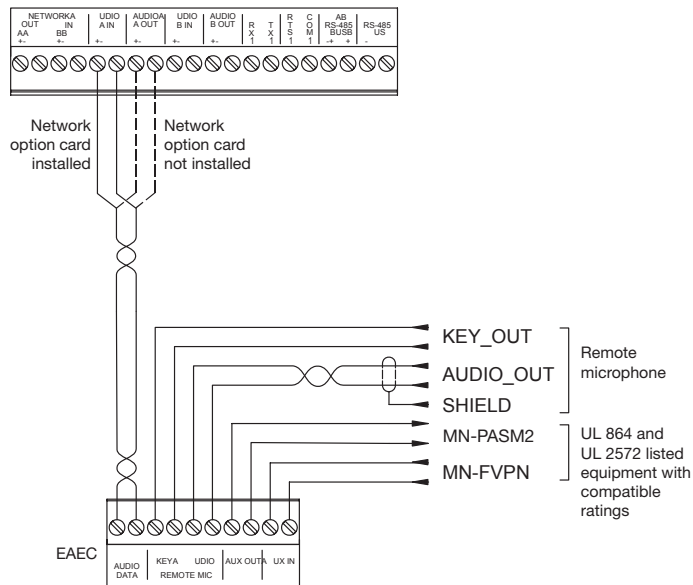

CLA-PS10 Class A Adapter Card

The CLA-PS10 Class A Adapter Card is an optional card used to convert the four Class B notification appliance/auxiliary power circuits on the power supply card to Class A.

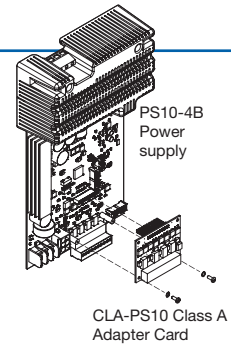

CLA-PS10 Specifications

Voltage	24 VDC	
Notification appliance/Auxiliary power circuits	UL rating	Special application or Regulated
	Quantity	4
Performance class	Class A	
Output current	Special 3.0 A; Regulated: 1.5 A each circuit	
EOLR	15 kΩ (UL P/N EOL-15, ULC P/N EOL-P1)	
Wiring	Supervised, power-limited	
Wire size	18 to 12 AWG (0.75 mm ² to 2.50 mm ²)	
Operating environment	Temperature	32 to 120 °F (0 to 49 °C)
	Relative humidity	0 to 93% noncondensing

Ordering Information

Intelligent Analog Control Panels

Model	Door Color	Language	Description
3X-SFS1B	Bronze	English	FACP, complete system with user interface, CPU, one loop with second loop expansion, three option card slots, four Class B NAC, universal 110/220v 10 amp power supply. Order 3-SDC1 for second loop.
3X-SFS1R	Red		
3X-SFS1Bi	Bronze	Selectable	
3X-SFS1Ri	Red		
TRIM6			Flush trim ring

Network communication option cards

3X-NET8	RS485, eight node max. Class A/B network. Use on 3-SFS systems only.
3X-NET	RS485, Class A/B network. For connection with node counts above eight or to EST3 systems.
3X-FIB8	Fiber, 8 node max. Uses MMXVR, SMXHI2, SMXLO2. Use on 3-SFS systems only.
3X-FIB	Fiber motherboard for connection to EST3 systems. Used with MMXVR, SMXHI2 and SMXLO2.
SMXLO2	Standard output single mode fiber optic transceiver
SMXHI2	High output single mode fiber optic transceiver
MMXVR	Standard output multimode fiber optic transceiver

Communication Options

3X-ETH1	Ethernet Adapter, 10/100. Provides Ethernet connection from system to 3-SDU for remote programming and diagnostics. Uses standard Ethernet cable (not supplied).
---------	--

Front Panel LED/Switch display modules

4X-12/S1GY	LED Display/Control Module - 12 Switches, 1 Green, 1 YELLOW LED per switch.
4X-12/S1RY	LED Display/Control Module - 12 Switches, 1 RED, 1 YELLOW LED per switch.
4X-12SR	LED Display/Control Module - 12 Switches with 12 RED LEDs.
4X-12RY	LED Display Module - 12 pairs of LEDs (1 Red; 1 Yellow)
4X-24Y	LED Display Module - 24 YELLOW
4X-24R	LED Display Module - 24 RED
4X-6/3S1G2Y	LED/Switch Module - six groups of three Switches with one LED each.
4X-6/3S1GYR	LED/Switch Module - six groups of three Switches with one LED each.
4X-4/3SGYWR	LED/Switch Module, four groups of three switches and four LEDs. LED colors: Green, Red, Yellow and White.
4X-LKF	Label Kit, French

Option Cards and Interfaces

3X-PMI	Paging Microphone Interface
3-SSDC1	Single Signature Driver Controller, c/w one 3-SDC1
3-SDDC1	Dual Signature Driver Controller, c/w two 3-SDC1s
3-SDC1	Signature Device Card - expands the 3X base panel to two loops
3-ZA20A	20 Watt Zoned Amplifier w/Class A/B Audio & Class A/B 24 VDC outputs
3-ZA20B	20 Watt Zoned Amplifier w/Class B Audio & Class B 24 VDC outputs
3-ZA40A	40 Watt Zoned Amplifier w/Class A/B Audio & Class A/B 24 VDC outputs
3-ZA40B	40 Watt Zoned Amplifier w/Class B Audio & Class B 24 VDC outputs
3-MODCOM	Modem/Dialer (DACT)
3-AADC1	Addressable Analog Module
3-IDC8/4	Initiating Device Circuit Module
3-LDSM	LED Display Support Module. Provides interface for one LED/Switch display module. Mounts in an option card slot where no Option cards are installed.
3-OPS	Off Premises Signaling module
CLA-PS10	Class A Adapter, PS10 NACs
CDR-3	PSNI Coder Module
GCI	Graphic Annunciator Driver Master, provides outputs for 32 LEDs and connection to common control switches and LEDs for R-Series annunciators.
GCIX	Graphic Annunciator Driver Expander, provides outputs for 48 LEDs and inputs for 24 switches.



Contact us...

Email: edwards.fire@fs.utc.com
Web: www.est-fire.com

EST is an **EDWARDS** brand.
1016 Corporate Park Drive
Mebane, NC 27302

In Canada, contact Chubb Edwards...
Email: inquiries@chubbedwards.com
Web: www.chubbedwards.com

© 2013 UTC Fire & Security Americas Corporation, Inc. All rights reserved. Specifications subject to change without notice. Edwards is part of UTC Climate, Controls & Security, a unit of United Technologies Corporation.

Accessories

PS10-4B	Power Supply, Replacement
SFS1-ELEC	Base Electronics, replacement
4X-LCD	Main user interface assembly, monochrome. Eight line 1/4 VGA LCD, four controls plus rotary knob. English language.
4X-LCD-LC	Main user interface assembly, monochrome. Eight Line 1/4 VGA LCD, four controls plus Rotary knob. Insertable language, shipped with English inserts. Order alternate languages separately.
4X-DR	Blank hinged local rail module door
4X-CAB6D	Replacement door, bronze
4X-CAB6DR	Replacement door, red
4X-CAB6B	Backbox, black
CAB6BEQ	Seismic hardening Kit for batteries up to 17Ah.

Note: For earthquake anchorage, including detailed mounting weights and center of gravity detail, please refer to *Seismic Application Guide 3101676-EN*. Approval of panel anchorage to site structure may require local AHJ, structural, or civil engineer review.

Related Data Sheets

- 85010-0129 -- Signature Driver Controller Modules
- 85010-0057 -- EST3 Zoned Audio Amplifiers
- 85010-0107 -- EST3 Modem Communicator
- 85010-0131 -- Fiber Optic Communications Interface
- 85010-0113 -- Network Short Haul Modem
- 85005-0128 -- R-Series Remote Annunciators
- 85010-0150 -- BMS Communication Bridges
- 85006-0067 -- FireWorks Grapical Interface